

CORES SYSTEM

A.A.G.
STUCCHI

EUTRAC

CORE5

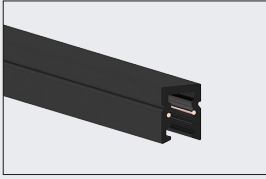

Surface track



Surface track with champagne film



Surface track with natural film

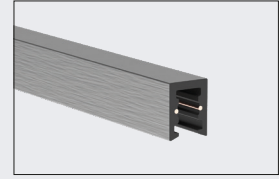

Surface track with stainless steel film

CORE5 covers

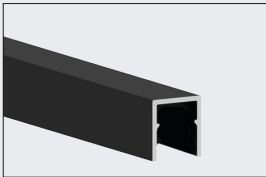

Surface aluminium S1 cover

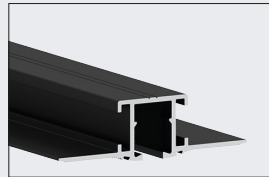

Trimless aluminium S3 cover



Double track aluminium S7 cover

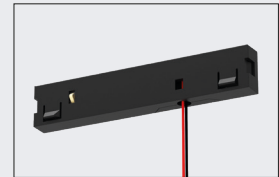

Single spot adapter

CORE5 adapter

CORE5 connections

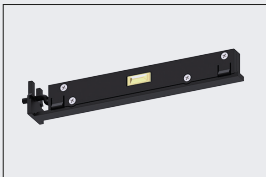

Concealed end-feed



Double concealed end-feed

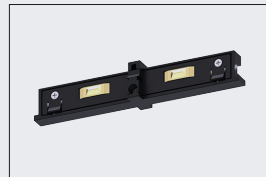

Joining connector

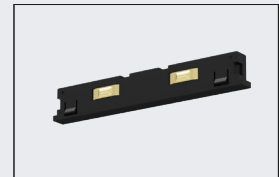

Joining connector

CORE5 end caps

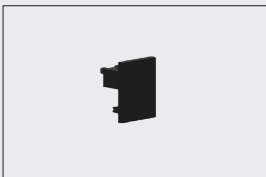

End cap

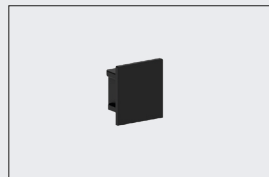

End cap for surface cover



End cap for trimless cover

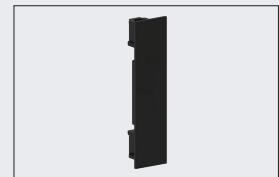

End cap for double emission cover

CORE5

Discover more



CORE5 is the first system based on CORE concept. The core is a track itself, made of a **proprietary polymer** which maintains the **mechanical and electrical features** of a standard track.

The core can be used as it is for ceiling or embedded applications, while the use of **aluminium covers** makes all the other installation types possible. Covers can be customized in colour, finishing, shape and size thus giving the maximum freedom and flexibility in all applications and **films** give an aesthetic touch to surface ones.

CORE5 main feature is the **track size which is even smaller**, thus conveying a very elegant touch to residential, retail or any other specific application where space for track installation is limited and attention to details is a must.

Tech info

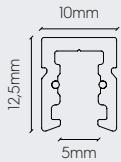

1 circuit: +/- 5A/60V dc

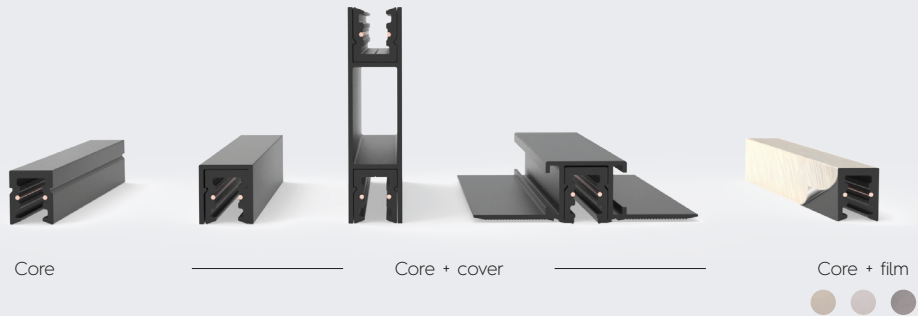

Materials:

Core: extruded body in black polymer

Covers: aluminium

Available cover colours: black embossed / white embossed

Available film colours: ● champagne ● natural ● stainless steel

Available lengths:



CORE5 mounting options

WOOD SHELF:

Ceiling



Embedded

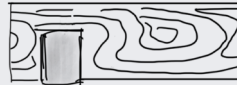

GLASS / METAL SHELF / DRYWALL:

Ceiling

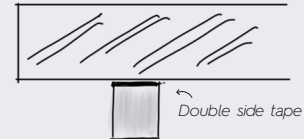

Inclined embedded



Side embedded

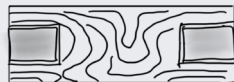

Light inside CORE5



SENZAFINE FLAT M5

Linear light modules for diffuse light

[mm]	n°. LED Mod	[K]	I LED	REAL FLUX [lm]	POWER [W]	CRI
345	1	2700 / 3000 / 4000	24V Constant voltage	240,7 / 251,6 / 268,2	4,3	≥90
642	2	2700 / 3000 / 4000	24V Constant voltage	481,5 / 503,3 / 536,7	8,6	≥90
938	3	2700 / 3000 / 4000	24V Constant voltage	722,3 / 755 / 804,8	12,9	≥90
1235	4	2700 / 3000 / 4000	24V Constant voltage	963,1 / 1006,7 / 1073,1	17,3	≥90



SPOTLIGHT

A tiny luminaire to complete CORE5 system with accent light

Optic	n°. LED Mod	[K]	I LED	REAL FLUX [lm]	POWER [W]	CRI
Lens 34°	1	2700 / 3000 / 4000	24V Constant voltage	70,2 / 76,7 / 87,7	2,0	≥90

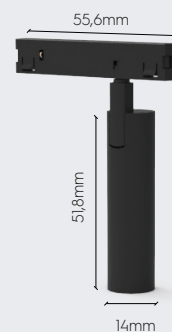

Surface Core / Core + trimless cover

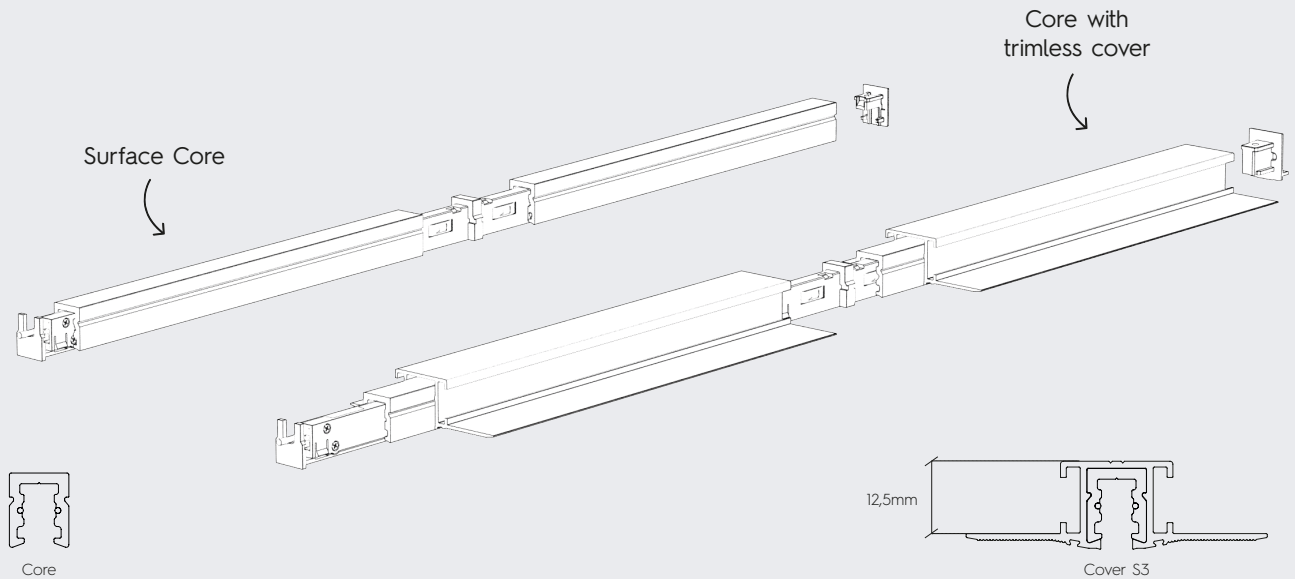

Core + suspended double track cover

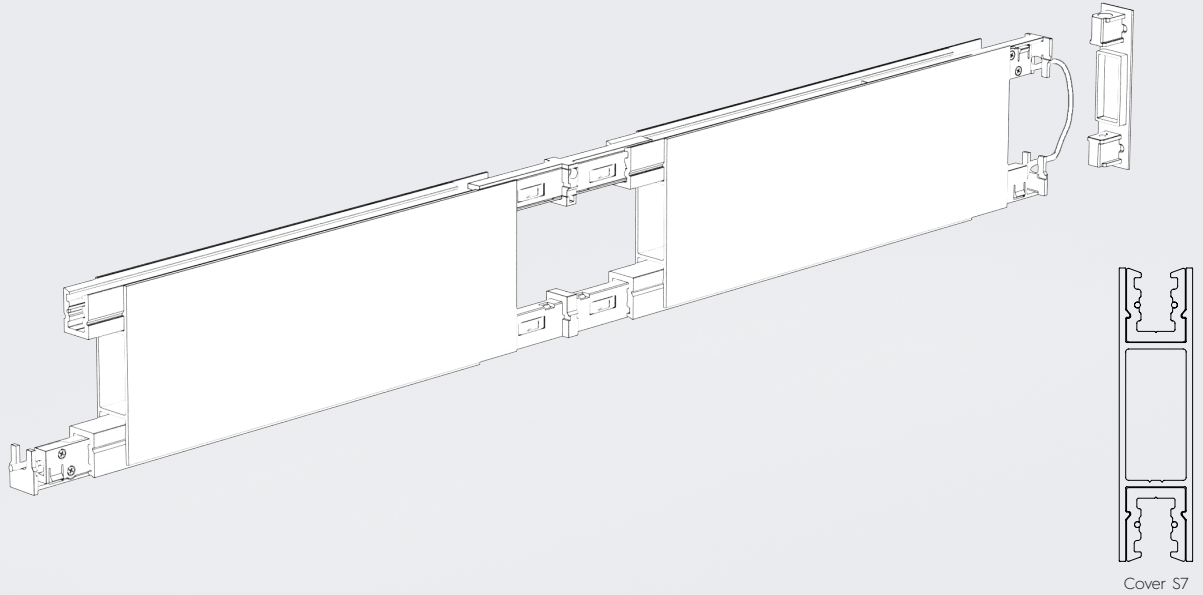

Suspended double track application with spotlights and indirect light